

Pump Model CPS 200-125-500

Speed 1450rpm

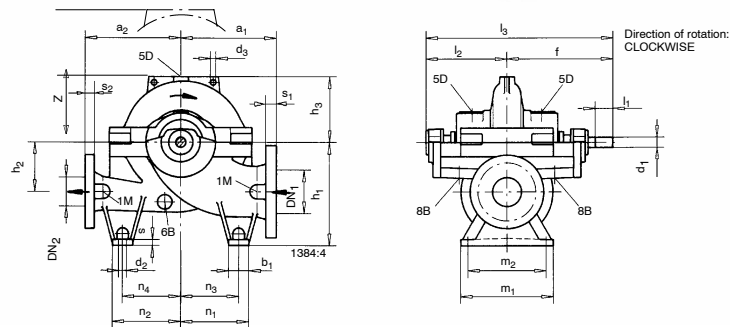
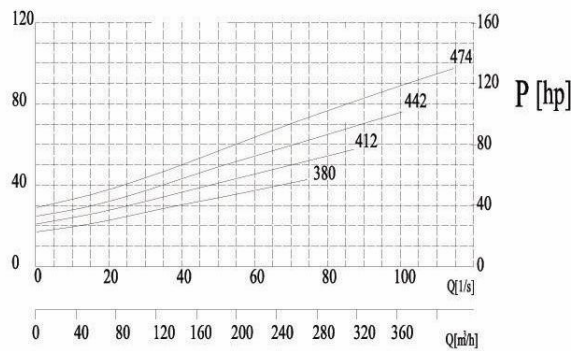
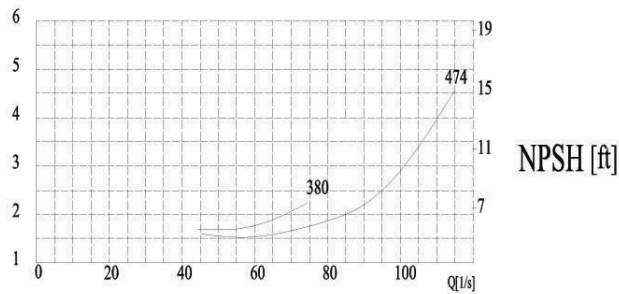
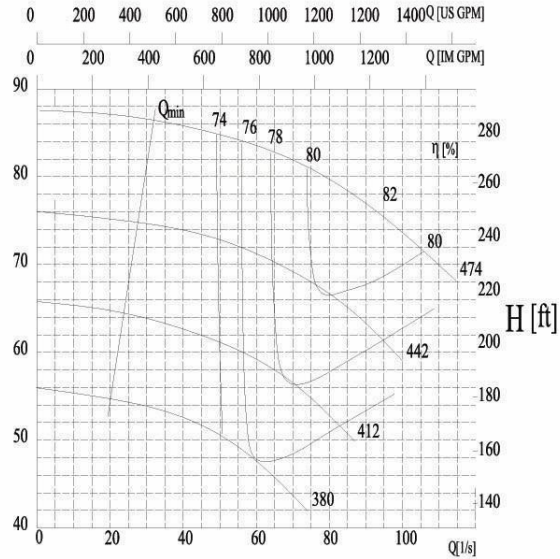

Pump Size	FLANGE DIMENSIONS				PUMP DIMENSIONS									
	DN1	DN2	s1	s2	a1	a2	d3	f	h1	h2	h3	l2	l3	z
CPS 200-125-500	200	125	41	35	450	450	19	515	400	200	305	366	881	610
	FOOT DIMENSIONS									SHAFT		PUMP WEIGHT		
	b1	d2	m1	m2	n1	n2	n3	n4	s	d1	L1	(kg)		
	70	18	390	340	315	315	280	280	20	45	100	335		